

Data sheet | Item number: 765-4102/100-000

8-Port-IO Link Master Class B; Profinet; DC 24 V / 2.0 A; 8xM12 connection;
WideLine

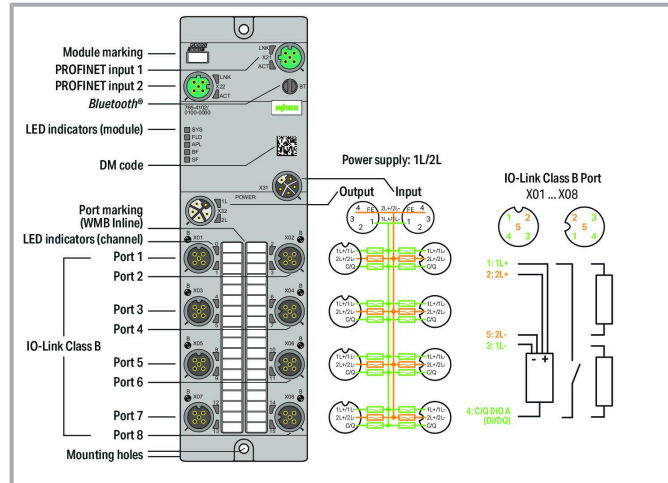

www.wago.com/765-4102/100-000



Data

Technical data

Fieldbus

Communication

PROFINET

PROFINET IO Device; 2-port switch, LLDP, MRP, SNMP

PROFINET

PROFINET IO Device; 2-port switch, LLDP, MRP, SNMP

Connection technology: communication/fieldbus

2 x D-coded M12; 4-pole

Interface standard

10BASE-T/100BASE-TX; potential-free

Autonegotiation; autocrossover

yes

PROFINET IO properties

PROFINET IO device; 2-port switch, LLDP, MRP, SNMP

Device Functions

Parameters

Input filter

Output current

Subject to changes. Please also observe the further product documentation!

WAGO GmbH & Co. KG

Hansastr. 27

32423 Minden

Phone: +49571 887-0 | Fax: +49571 887-169

Email: info.de@wago.com | Web: www.wago.com

Do you have any questions about our products?

We are always happy to take your call at +49 (571) 887-44222.

	Temperature
Diagnostics	Undervoltage; Overcurrent; Overload; Overtemperature
Device functions	Bluetooth® Bluetooth® OPC UA Server
Visualization	Android/iOS app Webserver

IO-Link Master

IO-Link Master classification	Class B; Specification V1.1
Port mode	IO-Link: autoconfig, manual, tool-based DI DO
Cycle time	400 µs (min.)
Operating mode	IO-Link master, DI or DO (adjustable for pin 4 per port); Supply voltage 2L (fixed for pin 2 per port)

IO-Link ports

Number of digital inputs	8
Number of digital outputs	8
Connection technology: inputs/outputs	8 x A-coded M12; 5-pole
Voltage signal type	24 VDC
Input characteristic	High-side switching
Input filter	0.2 ... 20 ms
Input characteristic	Type 3, per IEC 61131-2
Output current (per channel)	2 A (typ.) for DO
Supply current per port	1L (Pin 1): 1 A for IO-Link; 4 A (max.) for DIO; 2L (Pin 2): 4 A (max.)

Module Power Supply

Connection technology: supply	2 x L-coded M12; 5-pole
Supply voltage	24 VDC (18 ... 31.2 V); 1L/2L
Power consumption (max.)	16000 mA
Power consumption (note)	per supply line; overload- and short-circuit-protected
Reverse voltage protection	Yes

Geometrical Data

Width	60 mm / 2.362 inch
Height	30 mm / 1.181 inch

Subject to changes. Please also observe the further product documentation!

Depth	210 mm / 8.268 inch
-------	---------------------

Mechanical Data

Weight	610 g
Conformity marking	CE

Environmental Requirements

Surrounding air temperature (operation)	-25 ... +70 °C
Surrounding air temperature (storage)	-40 ... +80 °C
Protection type	IP67
Protection class	III per EN 61140, IEC 61140, VDE 0140-1
Operating altitude	0 ... 2000 m
Pollution degree (5)	3 per EN 60664-1
Overvoltage category	II (EN 60664-1)
Relative humidity (without condensation)	95 %
Vibration resistance	5g per IEC 60068-2-6
Shock resistance	Short-term: 50g/11 ms/half-sine per IEC 60068-2-27; Long-term: 30g/6 ms/half-sine per IEC 60068-2-29
EMC immunity to interference	per EN 61000-6-2
EMC emission of interference	per EN 61000-6-4

Commercial data

PU (SPU)	1 Stück
Packaging type	box
Country of origin	DE
GTIN	4055143949798
Customs tariff number	85371098990

Required accessories

Tool

Assembly tool

Item no.: 206-701	www.wago.com/206-701
--------------------------	----------------------------------------------------------------

Torque wrench M8 and M12; Assembly kit

Marking accessories

Marking strip



Item no.: 2009-110	www.wago.com/2009-110
---------------------------	------------------------------------------------------------------

Marking strips; for Smart Printer; on reel; not stretchable; plain; snap-on type; white

Subject to changes. Please also observe the further product documentation!

WAGO GmbH & Co. KG

Hansastr. 27

32423 Minden

Phone: +49571 887-0 | Fax: +49571 887-169

Email: info.de@wago.com | Web: www.wago.com

Do you have any questions about our products?

We are always happy to take your call at +49 (571) 887-44222.

Marker

	<p>Item no.: 2009-115 WMB-Inline; for Smart Printer; 1500 pieces on roll; stretchable 5 - 5.2 mm; plain; snap-on type; white</p>	www.wago.com/2009-115
-----------------------------------------------------------------------------------	---------------------------------------------------------------------------------------------------------------------------------------------	------------------------------------------------------------------

Cover

Cover

	<p>Item no.: 756-8102 M12 protective cap; for unused sockets</p>	www.wago.com/756-8102
	<p>Item no.: 756-8103 M12 protective cap; for unused plugs</p>	www.wago.com/756-8103

Optional accessories

Cables and pluggable connectors

Sensor/actuator cable

	<p>Item no.: 756-5402/050-010 Sensor/Actuator cable; M12A socket; straight; M12A plug; angled; 5-pole; Length: 1 m</p>	www.wago.com/756-5402/050-010
	<p>Item no.: 756-5311/050-015 Sensor/Actuator cable; M12A plug; straight; 5-pole; Length: 1.5 m</p>	www.wago.com/756-5311/050-015
	<p>Item no.: 756-5404/050-020 Sensor/Actuator cable; M12A socket; angled; M12A plug; angled; 5-pole; Length: 2 m</p>	www.wago.com/756-5404/050-020
	<p>Item no.: 756-5404/050-010 Sensor/Actuator cable; M12A socket; angled; M12A plug; angled; 5-pole; Length: 1 m</p>	www.wago.com/756-5404/050-010
	<p>Item no.: 756-5402/050-020 Sensor/Actuator cable; M12A socket; straight; M12A plug; angled; 5-pole; Length: 2 m</p>	www.wago.com/756-5402/050-020
	<p>Item no.: 756-5312/050-015 Sensor/Actuator cable; M12B socket; straight; 5-pole; Length: 1.5 m</p>	www.wago.com/756-5312/050-015
	<p>Item no.: 756-5312/050-050 Sensor/Actuator cable; M12B socket; straight; 5-pole; Length: 5 m</p>	www.wago.com/756-5312/050-050
	<p>Item no.: 756-5312/050-100 Sensor/Actuator cable; M12B socket; straight; 5-pole; Length: 10 m</p>	www.wago.com/756-5312/050-100

Subject to changes. Please also observe the further product documentation!

Item no.: 756-5403/050-020

Sensor/Actuator cable; M12A socket; angled; M12A plug; straight; 5-pole; Length: 2 m

www.wago.com/756-5403/050-020

Item no.: 756-5403/050-010

Sensor/Actuator cable; M12A socket; angled; M12A plug; straight; 5-pole; Length: 1 m

www.wago.com/756-5403/050-010

Item no.: 756-5311/050-100

Sensor/Actuator cable; M12A plug; straight; 5-pole; Length: 10 m

www.wago.com/756-5311/050-100

Item no.: 756-5311/050-050

Sensor/Actuator cable; M12A plug; straight; 5-pole; Length: 5 m

www.wago.com/756-5311/050-050

Item no.: 756-5401/050-010

Sensor/Actuator cable; M12A socket; straight; M12A plug; straight; 5-pole; Length: 1 m

www.wago.com/756-5401/050-010

Item no.: 756-5401/050-020

Sensor/Actuator cable; M12A socket; straight; M12A plug; straight; 5-pole; Length: 2 m

www.wago.com/756-5401/050-020

Configurable connectors

Item no.: 756-9202/050-000

Fitted pluggable connector; 5-pole; M12 plug, straight, A-coded; Spring

www.wago.com/756-9202/050-000

Item no.: 756-9205/050-000

Fitted pluggable connector; 5-pole; M12 plug, right angle; Spring

www.wago.com/756-9205/050-000



Item no.: 756-9711/050-000

Fitted pluggable connector; 5-pole, shielded; M12 socket, straight; IDC technology

www.wago.com/756-9711/050-000



Item no.: 756-9701/050-000

Fitted pluggable connector; 5-pole, shielded; M12 plug, straight; IDC technology

www.wago.com/756-9701/050-000

Configurable shielded connectors

Item no.: 756-9501/060-000

Fitted pluggable connector; 5-pole, shielded; M12 plug, straight, D-coded; Spring

www.wago.com/756-9501/060-000

Item no.: 756-9501/040-000

Accessories; M12 plug, right angle; 4-pole

www.wago.com/756-9501/040-000

Power cable

Subject to changes. Please also observe the further product documentation!

WAGO GmbH & Co. KG

Hansastr. 27

32423 Minden

Phone: +49571 887-0 | Fax: +49571 887-169

Email: info.de@wago.com | Web: www.wago.com

Do you have any questions about our products?

We are always happy to take your call at +49 (571) 887-44222.



Item no.: 756-3501/050-075
Power cable; M12L socket; straight; 5-pole; Length: 7.5 m

www.wago.com/756-3501/050-075



Item no.: 756-3501/050-100
Power cable; M12L socket; straight; 5-pole; Length: 10 m

www.wago.com/756-3501/050-100



Item no.: 756-3501/050-150
Power cable; M12L socket; straight; 5-pole; Length: 15 m

www.wago.com/756-3501/050-150



Item no.: 756-3501/050-050
Power cable; M12L socket; straight; 5-pole; Length: 5 m

www.wago.com/756-3501/050-050



Item no.: 756-3502/050-050
Power cable; M12L socket; angled; 5-pole; Length: 5 m

www.wago.com/756-3502/050-050



Item no.: 756-3502/050-150
Power cable; M12L socket; angled; 5-pole; Length: 15 m

www.wago.com/756-3502/050-150



Item no.: 756-3502/050-075
Power cable; M12L socket; angled; 5-pole; Length: 7.5 m

www.wago.com/756-3502/050-075



Item no.: 756-3502/050-100
Power cable; M12L socket; angled; 5-pole; Length: 10 m

www.wago.com/756-3502/050-100



Item no.: 756-3503/050-075
Power cable; M12L plug; straight; 5-pole; Length: 7.5 m

www.wago.com/756-3503/050-075



Item no.: 756-3503/050-150
Power cable; M12L plug; straight; 5-pole; Length: 15 m













www.wago.com/756-3503/050-150















Item no.: 756-3503/050-100
Power cable; M12L plug; straight; 5-pole; Length: 10 m

www.wago.com/756-3503/050-100

Subject to changes. Please also observe the further product documentation!

	Item no.: 756-3505/050-003 Power cable; M12L socket; straight; M12L plug; straight; 5-pole; Length: 0.3 m	www.wago.com/756-3505/050-003
	Item no.: 756-3505/050-005 Power cable; M12L socket; straight; M12L plug; straight; 5-pole; Length: 0.5 m	www.wago.com/756-3505/050-005
	Item no.: 756-3505/050-020 Power cable; M12L socket; straight; M12L plug; straight; 5-pole; Length: 2 m	www.wago.com/756-3505/050-020
	Item no.: 756-3505/050-010 Power cable; M12L socket; straight; M12L plug; straight; 5-pole; Length: 1 m	www.wago.com/756-3505/050-010
	Item no.: 756-3505/050-050 Power cable; M12L socket; straight; M12L plug; straight; 5-pole; Length: 5 m	www.wago.com/756-3505/050-050
	Item no.: 756-3505/050-075 Power cable; M12L socket; straight; M12L plug; straight; 5-pole; Length: 7.5 m	www.wago.com/756-3505/050-075
	Item no.: 756-3505/050-100 Power cable; M12L socket; straight; M12L plug; straight; 5-pole; Length: 10 m	www.wago.com/756-3505/050-100
	Item no.: 756-3506/050-100 Power cable; M12L socket; angled; M12L plug; angled; 5-pole; Length: 10 m	www.wago.com/756-3506/050-100
	Item no.: 756-3506/050-075 Power cable; M12L socket; angled; M12L plug; angled; 5-pole; Length: 7.5 m	www.wago.com/756-3506/050-075
	Item no.: 756-3506/050-150 Power cable; M12L socket; angled; M12L plug; angled; 5-pole; Length: 15 m	www.wago.com/756-3506/050-150
	Item no.: 756-3501/050-020 Power cable; M12L socket; straight; 5-pole; Length: 2 m	www.wago.com/756-3501/050-020
	Item no.: 756-3502/050-020 Power cable; M12L socket; angled; 5-pole; Length: 2 m	www.wago.com/756-3502/050-020
	Item no.: 756-3503/050-020 Power cable; M12L plug; straight; 5-pole; Length: 2 m	www.wago.com/756-3503/050-020

Subject to changes. Please also observe the further product documentation!

	Item no.: 756-3503/050-050 Power cable; M12L plug; straight; 5-pole; Length: 5 m	www.wago.com/756-3503/050-050
	Item no.: 756-3504/050-020 Power cable; M12L plug; angled; 5-pole; Length: 2 m	www.wago.com/756-3504/050-020
	Item no.: 756-3504/050-050 Power cable; M12L plug; angled; 5-pole; Length: 5 m	www.wago.com/756-3504/050-050
	Item no.: 756-3504/050-075 Power cable; M12L plug; angled; 5-pole; Length: 7.5 m	www.wago.com/756-3504/050-075
	Item no.: 756-3504/050-100 Power cable; M12L plug; angled; 5-pole; Length: 10 m	www.wago.com/756-3504/050-100
	Item no.: 756-3504/050-150 Power cable; M12L plug; angled; 5-pole; Length: 15 m	www.wago.com/756-3504/050-150
	Item no.: 756-3505/050-150 Power cable; M12L socket; straight; M12L plug; straight; 5-pole; Length: 15 m	www.wago.com/756-3505/050-150
	Item no.: 756-3506/050-003 Power cable; M12L socket; angled; M12L plug; angled; 5-pole; Length: 0.3 m	www.wago.com/756-3506/050-003
	Item no.: 756-3506/050-005 Power cable; M12L socket; angled; M12L plug; angled; 5-pole; Length: 0.5 m	www.wago.com/756-3506/050-005
	Item no.: 756-3506/050-020 Power cable; M12L socket; angled; M12L plug; angled; 5-pole; Length: 2 m	www.wago.com/756-3506/050-020
	Item no.: 756-3506/050-010 Power cable; M12L socket; angled; M12L plug; angled; 5-pole; Length: 1 m	www.wago.com/756-3506/050-010
	Item no.: 756-3506/050-050 Power cable; M12L socket; angled; M12L plug; angled; 5-pole; Length: 5 m	www.wago.com/756-3506/050-050
Distribution connector		

Subject to changes. Please also observe the further product documentation!



Item no.: 756-9301/050-000
Accessories; 5-pole

www.wago.com/756-9301/050-000

Adapter



Item no.: 756-9503/040-000
Accessories; 4-pole

www.wago.com/756-9503/040-000

Item no.: 756-9504/040-000
Accessories; 4-pole

www.wago.com/756-9504/040-000

ETHERNET/PROFINET cable



Item no.: 756-1202/060-200
ETHERNET cable; M12D plug; angled; 4-pole; Length: 20 m

www.wago.com/756-1202/060-200



Item no.: 756-1201/060-100
ETHERNET cable; M12D plug; straight; 4-pole; Length: 10 m

www.wago.com/756-1201/060-100



Item no.: 756-1201/060-050
ETHERNET cable; M12D plug; straight; 4-pole; Length: 5 m

www.wago.com/756-1201/060-050



Item no.: 756-1203/060-050
ETHERNET cable; M12D plug; straight; M12D plug; straight; 4-pole; Length: 5 m

www.wago.com/756-1203/060-050



Item no.: 756-1203/060-020
ETHERNET cable; M12D plug; straight; M12D plug; straight; 4-pole; Length: 2 m

www.wago.com/756-1203/060-020



Item no.: 756-1202/060-020
ETHERNET cable; M12D plug; angled; 4-pole; Length: 2 m

www.wago.com/756-1202/060-020



Item no.: 756-1201/060-200
ETHERNET cable; M12D plug; straight; 4-pole; Length: 20 m











www.wago.com/756-1201/060-200



Item no.: 756-1204/060-050
ETHERNET cable; M12D plug; angled; M12D plug; angled; 4-pole; Length: 5 m

www.wago.com/756-1204/060-050

Subject to changes. Please also observe the further product documentation!

	Item no.: 756-1204/060-100 ETHERNET cable; M12D plug; angled; M12D plug; angled; 4-pole; Length: 10 m	www.wago.com/756-1204/060-100
	Item no.: 756-1204/060-200 ETHERNET cable; M12D plug; angled; M12D plug; angled; 4-pole; Length: 20 m	www.wago.com/756-1204/060-200
	Item no.: 756-1203/060-200 ETHERNET cable; M12D plug; straight; M12D plug; straight; 4-pole; Length: 20 m	www.wago.com/756-1203/060-200
	Item no.: 756-1203/060-100 ETHERNET cable; M12D plug; straight; M12D plug; straight; 4-pole; Length: 10 m	www.wago.com/756-1203/060-100
	Item no.: 756-1204/060-010 ETHERNET cable; M12D plug; angled; M12D plug; angled; 4-pole; Length: 0.1 m	www.wago.com/756-1204/060-010
	Item no.: 756-1204/060-030 ETHERNET cable; M12D plug; angled; M12D plug; angled; 4-pole; Length: 3 m	www.wago.com/756-1204/060-030
	Item no.: 756-1204/060-020 ETHERNET cable; M12D plug; angled; M12D plug; angled; 4-pole; Length: 2 m	www.wago.com/756-1204/060-020
	Item no.: 756-1202/060-050 ETHERNET cable; M12D plug; angled; 4-pole; Length: 5 m	www.wago.com/756-1202/060-050
	Item no.: 756-1202/060-100 ETHERNET cable; M12D plug; angled; 4-pole; Length: 10 m	www.wago.com/756-1202/060-100
	Item no.: 756-1201/060-020 ETHERNET cable; M12D plug; straight; 4-pole; Length: 2 m	www.wago.com/756-1201/060-020

Downloads

Documentation

Manual

8-Port IO-Link Master Class B; Profinet DC 24 V / 2.0 A; 8xM12 Connection; WideLine	V 2.1.0 2020年11月30日	pdf 4.2 MB	Download
----------------------------------------------------------------------------------------	------------------------	---------------	----------

Subject to changes. Please also observe the further product documentation!



System Description

WAGO I/O System Field; General Product Information

pdf
708.2 kB

[Download](#)

Engineering-Software

WAGO IO-Link Configurator

WAGO IO-Link Configurator

V5.1.1-6015

ZIP

[Download](#)

2021年8月24日

159.6 MB

WAGO IO-Link Configurator allows configuration, parameterization, operation and monitoring of WAGO IO-Link Masters in the WAGO I/O System 750 and WAGO I/O System Field, and especially of the WAGO IO-Link devices connected to them.

Additionally, WAGO IO-Link Configurator can be used for complete configuration and operation of all IO-Link devices of third-party manufacturers, as long as they comply with the IO-Link specification. A product's process data can be visualized graphically and stored in trend curves. Up to eight elements can be selected for visualization, and the data can be recorded for up to 24 hours.

Device description files for the IO-Link Masters (IOLM) or IO-Link Devices (IODD) can be used to integrate new devices into the tool at any time. Convenient access to the IO-Link user organization's IODDfinder is available for the IODDs. This allows automated, selective download of IODDs when integrating new IO-Link devices. An integrated IODD viewer allows detailed insight into the IODD device description.

WAGO IO-Link Configurator can be used either as a standalone program or integrated into engineering systems with a TCI interface and *WAGO-I/O-CHECK*.

IO-Link Configurator can also be used to integrate the IO-Link Master (750-657) of the WAGO I/O System 750 Series and to access all the configurator's functions. This is made possible by the WAGO I/O System 750 IO-Link Adapter, which can be retrofitted. The WAGO I/O System 750 IO-Link Adapter requires the current version of WAGO IO-Link Configurator and a current version of *WAGO-I/O-CHECK*.

In addition, the download file contains the device descriptions for the respective fieldbus systems of the WAGO I/O System Field modules. These are pre-installed in the Configurator setup.

The WAGO IO-Link Configurator license is assigned to the specific PC on which it is installed (a workstation license).

Register now and test our engineering software for 30 days at no cost.

CAD/CAE-Data

CAD data

2D/3D Models 765-4102/100-000

URL

[Download](#)

CAE data

ZUKEN Portal 765-4102/100-000

URL

[Download](#)

Subject to changes. Please also observe the further product documentation!

WAGO GmbH & Co. KG

Hansastr. 27

32423 Minden

Phone: +49571 887-0 | Fax: +49571 887-169

Email: info.de@wago.com | Web: www.wago.com

Do you have any questions about our products?

We are always happy to take your call at +49 (571) 887-44222.



Device Files

Device Description File

750-916; GSD-Dateien der Version 2.x für PROFINET/ Serie 750/753, 765, 767 und 852	2.9 2021年10月15日	zip 2.5 MB	Download
Gerätebeschreibungsdateien 765-41xx, 765-11xx, PROFINET	V1_1_0_20	zip 27 B	Download

Environmental Product Compliance

Compliance Search

Environmental Product Compliance 765-4102/100-000 8-Port-IO Link Master Class B; Profinet; DC 24 V / 2.0 A; 8xM12 connection; WideLine	URL	Download
-------------------------------------------------------------------------------------------------------------------------------------------	-----	----------

Installation Notes

Product family

WAGO I/O System Field
[Show all products from the family](#)

Subject to changes. Please also observe the further product documentation!

WAGO GmbH & Co. KG
Hansastr. 27
32423 Minden
Phone: +49571 887-0 | Fax: +49571 887-169
Email: info.de@wago.com | Web: www.wago.com

Do you have any questions about our products?
We are always happy to take your call at +49 (571) 887-44222.